

Article number: 01020271

Description: Retaining ring J12 DIN472  
Stainless 411

## Measures

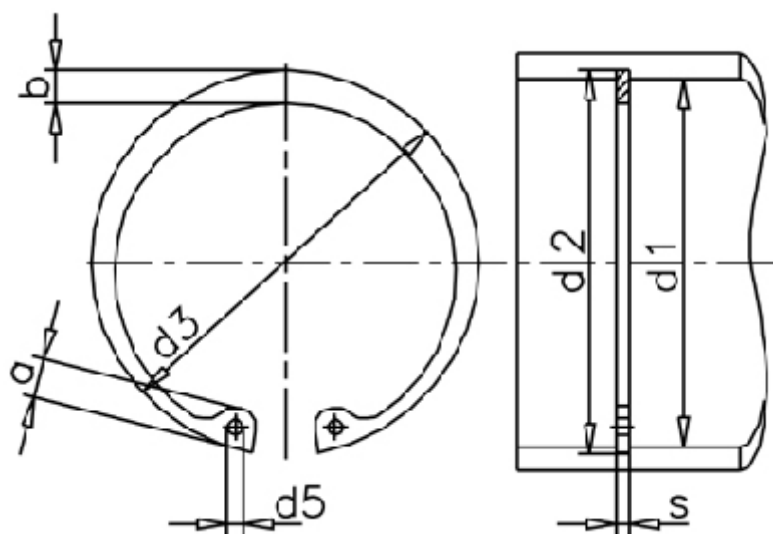

a max	= 3.4	FN kN	= 1.60	t	= 0.25
AN mm <sup>2</sup>	= 9.6	FRg kN	= 2.3	tol	= +0,11
b	= 1.7	FR kN	= 4.0	tol	= +0,36-1,10
d1	= 12	g	= 0.5	tol	= -0.06
d2	= 12.5	K kN-mm	= 20.2	Tong	= ZGJ-1
d3	= 13.00	m min	= 1.10	Weight kg/1000	= 0.37
d5 min	= 1.5	Nominal drive	= 0.8		
Description = J 12		s	= 1.00		